

0 601 475 037

Issue } 02-05-09 Fig./Abb. 1
Stand }

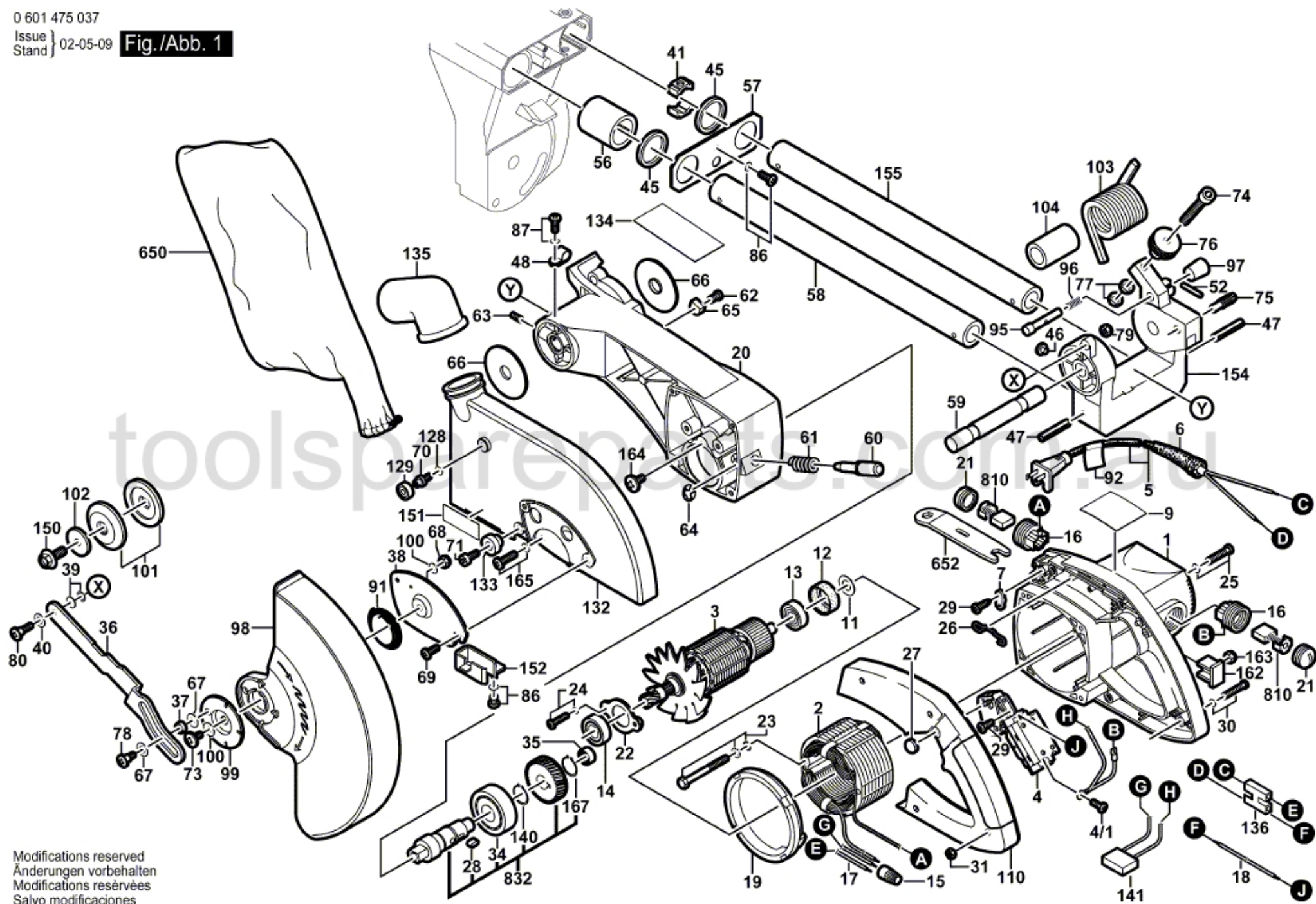

Modifications reserved
Änderungen vorbehalten
Modifications réservées
Salvo modificaciones